



Wien

Desk entirely covered in hard leather, with two drawer units covered in hard leather.

Scrivania completamente rivestita in cuoio con due cassettiere rivestite in cuoio.

Bureau entièrement recouvert de cuir sellier avec deux blocs tiroirs recouverts de cuir sellier.

Schreibtisch komplett mit Leder bespannt, mit zwei Schubladenelementen, ebenfalls mit Leder bespannt.

Escritorio completamente tapizado de cuero, con dos cajoneras tapizadas de cuero.







Cabinet 270 Wengé + Panel 250



693



Table 361



433



46



47



224

706

526







Conference Tables

The unmistakable sign of prestige. Tables meeting the requirements of our times.

Comfort, convenience, functionality combined with elegance, style and refinement. A place where best to meet, manage and organise people and activities.

Il segno inconfondibile del prestigio. Tavoli che rispondono alle esigenze dei tempi che stiamo vivendo. Comodità, comfort, funzionalità combinati ad eleganza, stile, raffinatezza. Un luogo per incontrare, dirigere, organizzare al meglio le attività e le persone.

Le signe unique du prestige. Des tables qui répondent aux exigences du travail d'aujourd'hui. La commodité, le confort, la fonctionnalité associées à l'élégance, au style, au raffinement. Un endroit pour rencontrer, diriger, organiser au mieux les activités et les personnes.

Ein Einrichtungsstück von unverkennbar hohem Prestige. Tische, die den Bedürfnissen unserer heutigen Zeit entsprechen. Bequemlichkeit, Komfort, Zweckmäßigkeit in Verbindung mit Eleganz, Stil, Raffinesse. Ein Ort für Begegnungen, Führungspersönlichkeiten, für optimale Organisation von Arbeit und Menschen.

La sensación inconfundible del prestigio. Mesas que responden a las exigencias de las épocas que estamos viviendo. La comodidad, el confort y la funcionalidad combinados con la elegancia, el estilo y el refinamiento. Un espacio para reunirse, dirigir y organizar a la perfección las actividades y las personas.

The tops are available with full-grain leather or leatherette covering. The bases are in marble, full-grain leather, split leather or wood. The tables are also made to measure in different sizes, shapes and finishes, to meet any requirement with maximum versatility.

I piani sono disponibili con rivestimento in cuoio pieno fiore o in cuoietto. Le basi in marmo, in cuoio pieno fiore, in cuoietto o in legno. I tavoli vengono costruiti anche su misura, in svariate dimensioni, forme e finiture, per qualsiasi esigenza e nel segno della massima versatilità.

Les plateaux sont disponibles avec revêtement en cuir pleine fleur ou en cuir rectifié. Les bases sont en marbre, en cuir pleine fleur, en croûte de cuir ou en bois. Les tables sont construites également sur mesure, en différentes dimensions, formes et finitions, pour satisfaire tous les besoins, à l'encontre de la plus grande polyvalence.

Die Tischplatten sind mit Überzug aus Vollnarbenleder oder Spaltleder verfügbar. Die Gestelle sind aus Marmor, Sattelle, Spaltleder oder aus Holz. Die Tische werden auch nach Maß gefertigt, in verschiedenen Abmessungen, Formen und Ausführungen, für jedes Bedürfnis und im Zeichen größter Vielseitigkeit.

Los tableros están disponibles con revestimiento de cuero plena flor o de serraje. Las bases son de mármol, de cuero plena flor, de "cuoietto" o de madera. Las mesas se construyen también a medida, en distintas dimensiones, formas y acabados, para cualquier exigencia ya la enseña de la máxima versatilidad.

535

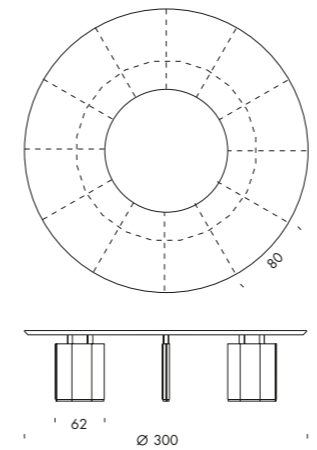

528 - 529

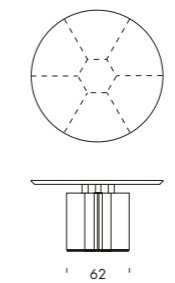



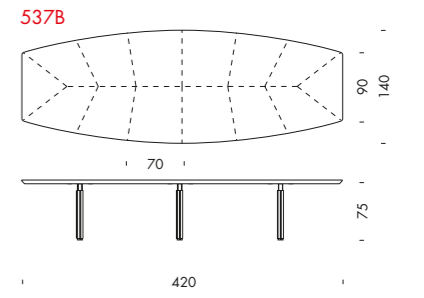
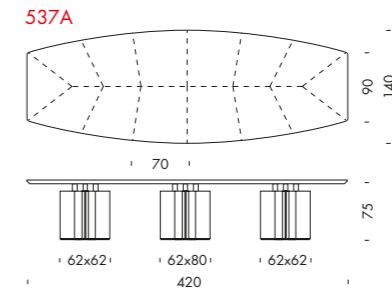
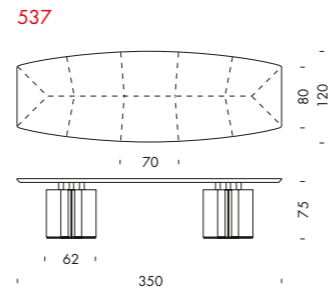
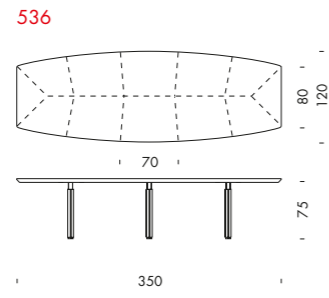
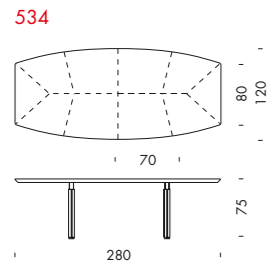



cabinet 255

table 534

armchair 548

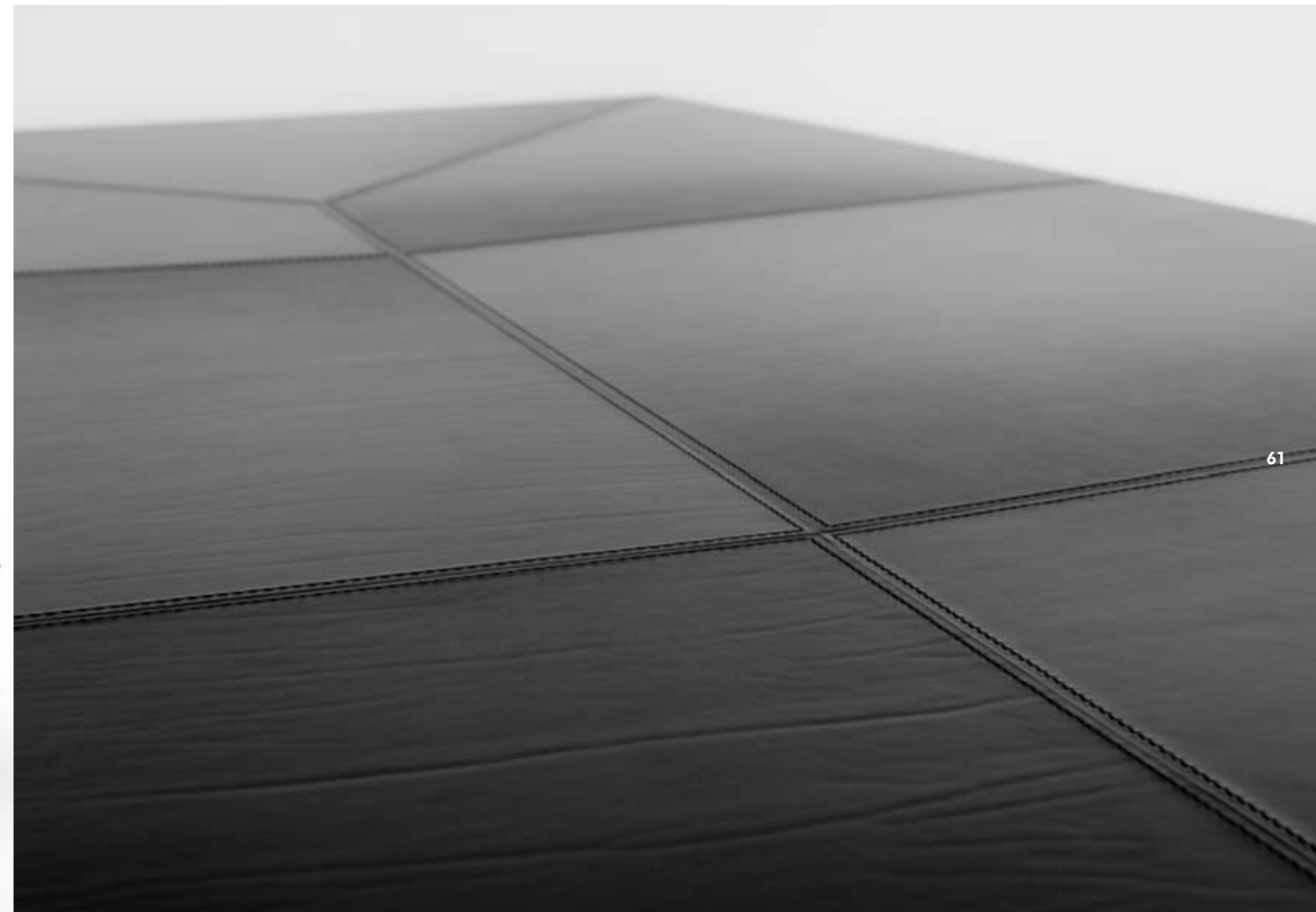





armchair 703

table 537A



table 537A

armchair 506

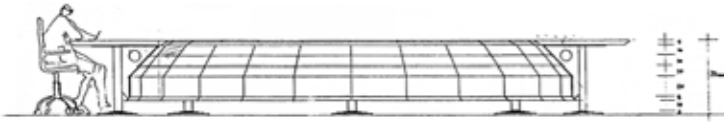
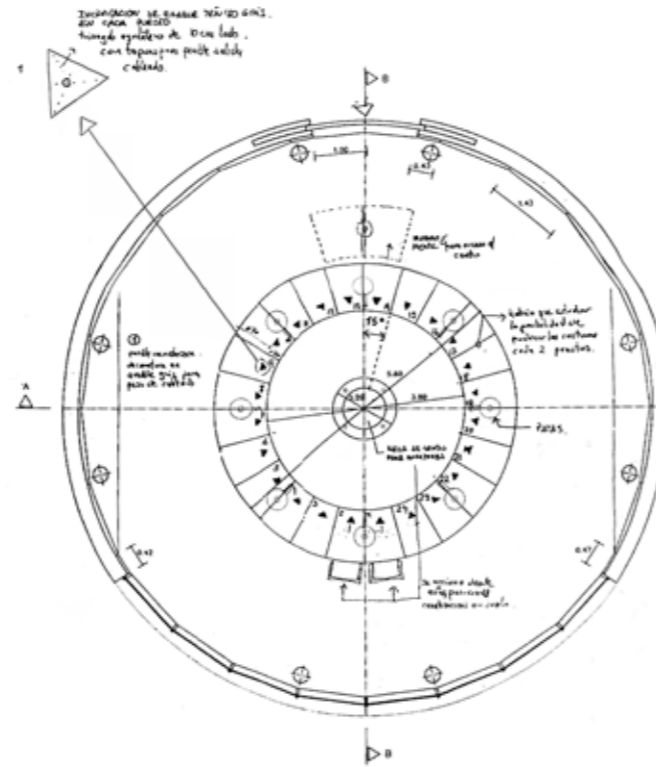
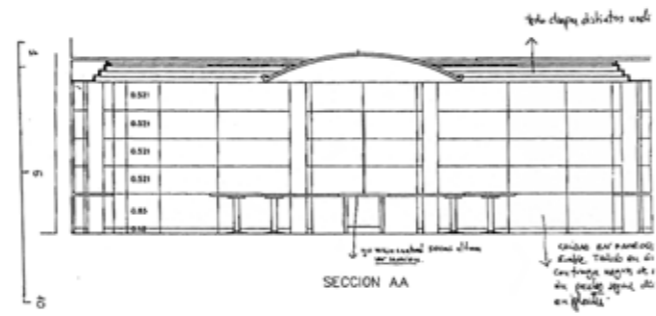
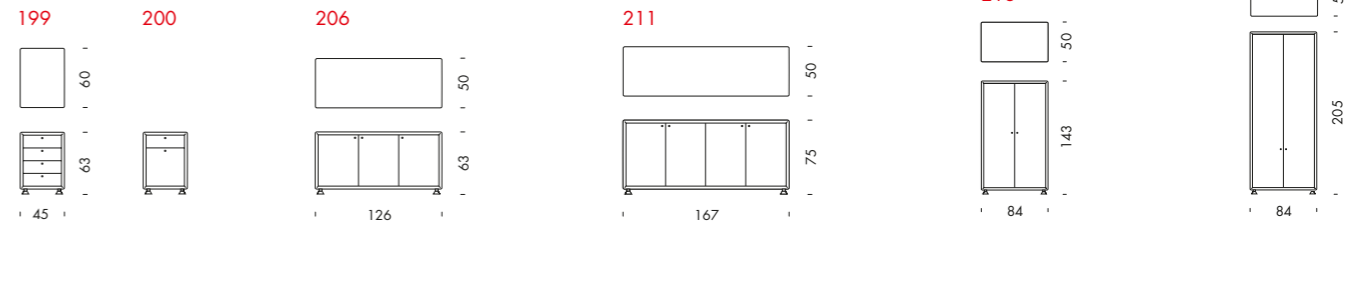
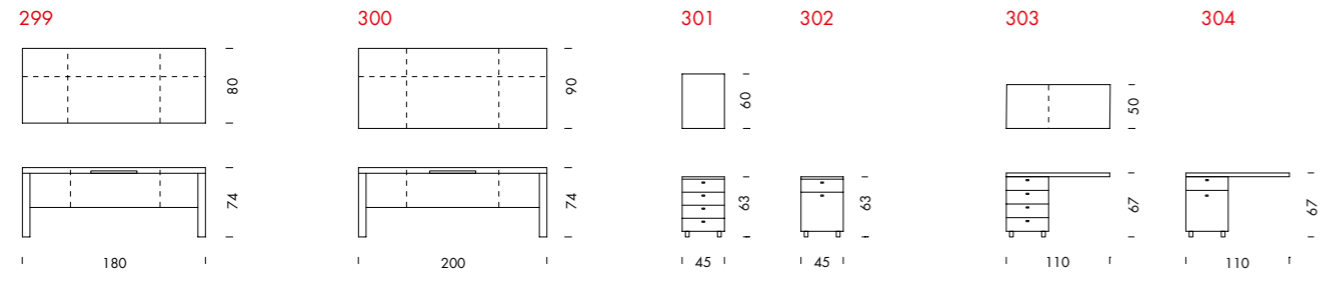

Table 535 - Ø 600



Athena



Epico

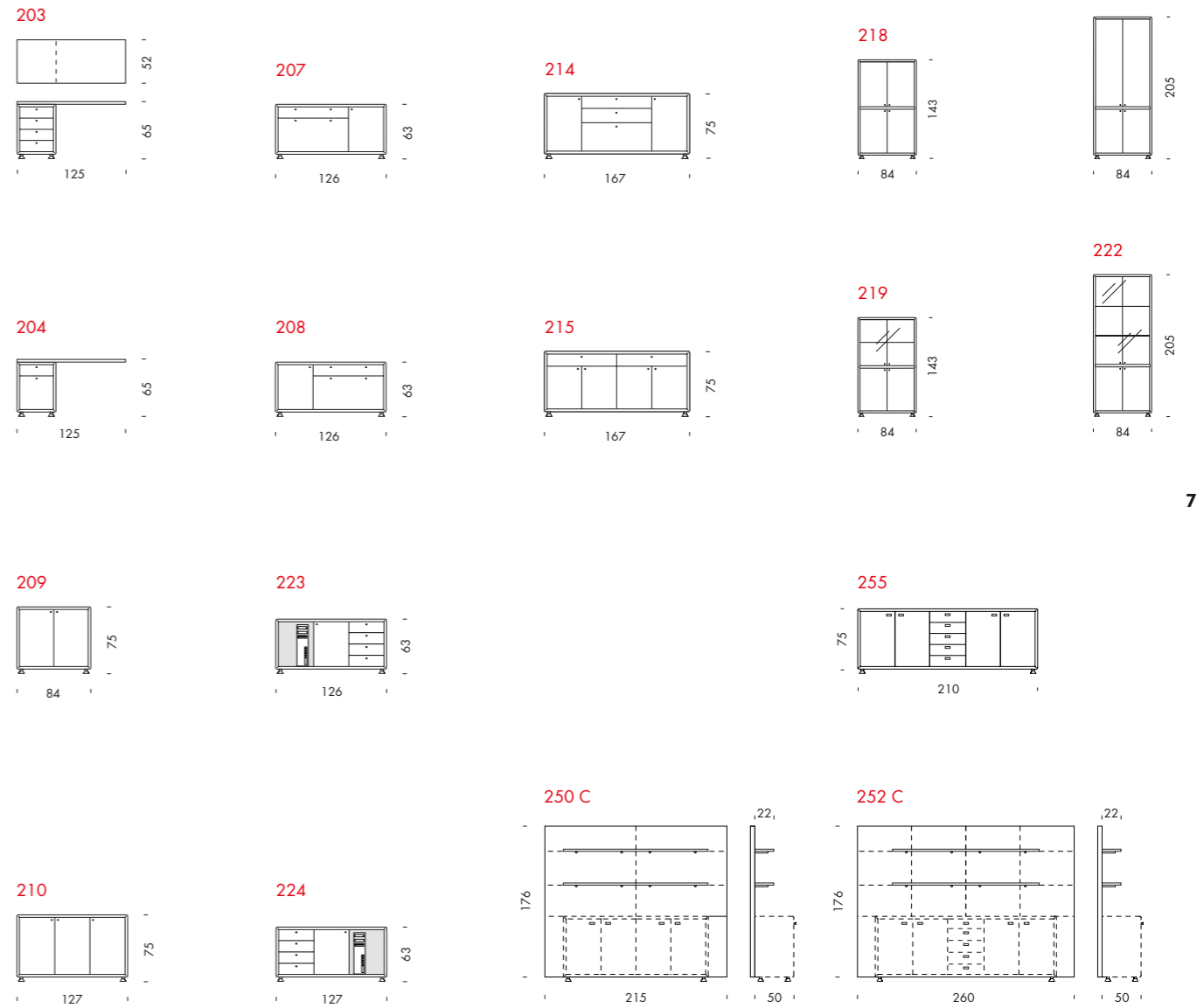
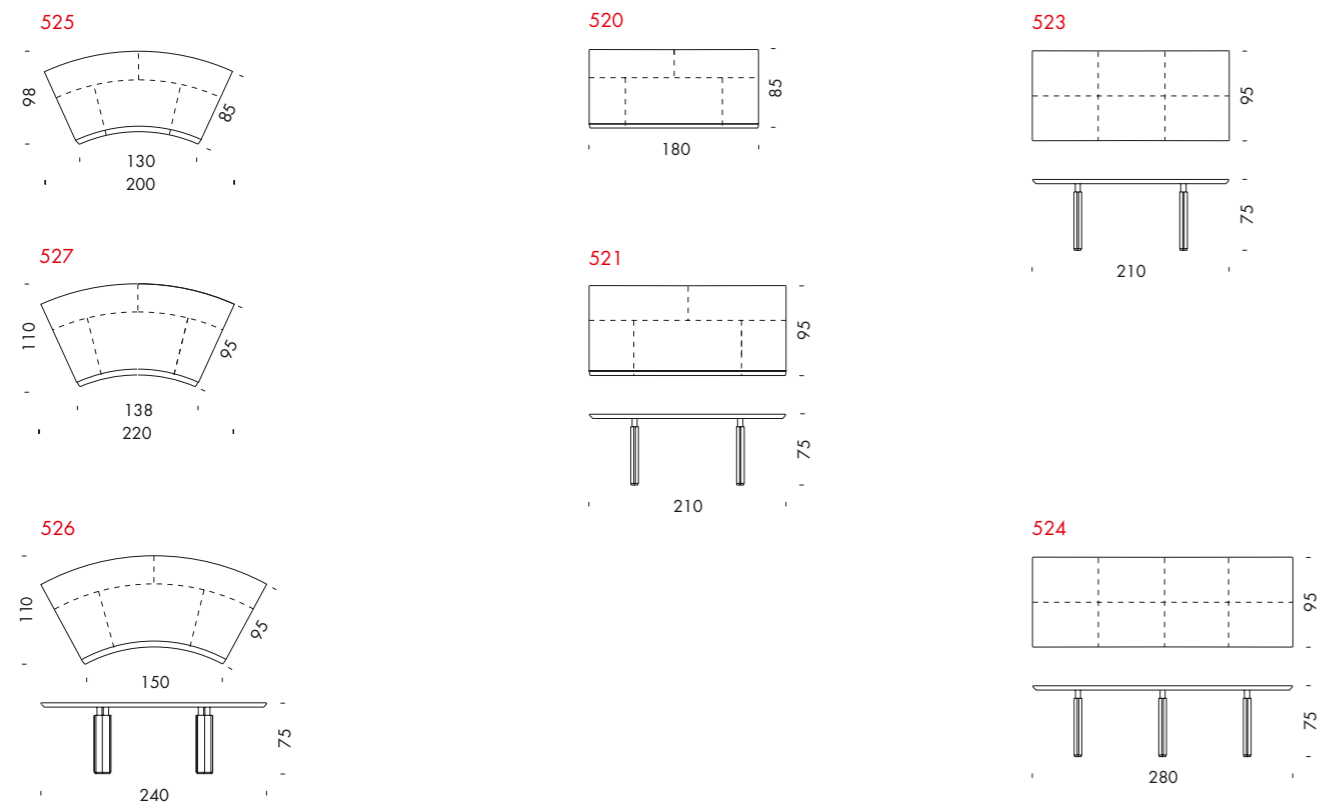

Wien

